











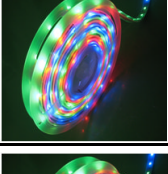
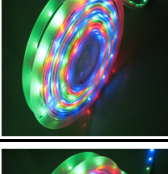
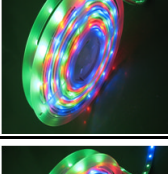
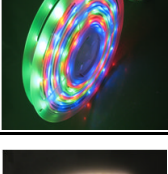
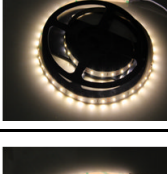
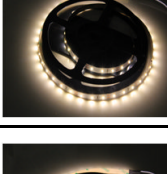
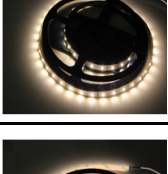

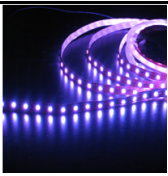
LED Flex Strip Lighting - Wholesale Prices

Item	Article No.	Picture	Description	Unit price (US\$)	Unit price (US\$)	Unit price (US\$)	Unit price (US\$)
	LED Flex Strips			MOQ=100 reels	500 pcs	1k pcs	2k pcs
1	W5050W/WW/R/G/B/YA/RGB (16.4' ea.)		7.5W/M, 30LED/M , Waterproof, DC12V, White,Warm White, Red, Yellow, Blue, Green, Amber	\$52.00	\$48.00	\$46.00	\$44.00
2	5050W/WW/R/G/B/YA/RGB (16.4' ea.)		7.5W/M, 30LED/M , Non-waterproof, DC12V, White,Warm White, Red, Yellow, Blue, Green, Amber	\$48.00	\$44.00	\$42.00	\$40.00
3	W5050W/WW/R/G/B/YA/RGB (16.4 ea.)		15W/M, 60LED/M , Waterproof, DC12V, White,Warm White, Red, Yellow, Blue, Green, Amber	\$72.00	\$68.00	\$66.00	\$64.00
4	5050W/WW/R/G/B/YA/RGB (16.4' ea.)		15W/M, 60LED/M , Non-waterproof, DC12V, White,Warm White, Red, Yellow, Blue, Green, Amber	\$68.00	\$64.00	\$62.00	\$60.00
5	W3528W/WW/R/G/B/Y/A (16.4' ea.)		4.8W/M, 60LED/M, Waterproof, DC12V, White,Warm White, Red, Yellow, Blue, Green, Amber	\$32.00	\$28.00	\$26.00	\$24.00
6	3528W/WW/R/G/B/Y/A (16.4' ea.)		4.8W/M, 60LED/M, Non-waterproof, DC12V, White,Warm White, Red, Yellow, Blue, Green, Amber	\$28.00	\$24.00	\$22.00	\$20.00
7	D5050RGB (16.4' ea)		Digital Dream Color LED Strip, 9.6W/M, 30LED/M , Non-waterproof, DC12V, White,Warm White, Red, Yellow, Blue, Green, Amber	\$96.00	\$92.00	\$90.00	\$88.00
8	DW5050RGB (16.4' ea.)		Digital Dream Color LED Strip,9.6W/M, 30LED/M , Waterproof, DC12V, White,Warm White, Red, Yellow, Blue, Green, Amber	\$100.00	\$96.00	\$94.00	\$92.00
9	W335W/WW/R/G/B/Y/A (16.4' ea.)		Side-view LED strip,4.8W/M, 60LED/M, Waterproof, DC12V, White,Warm White, Red, Yellow, Blue, Green, Amber	\$64.00	\$60.00	\$56.00	\$54.00
10	335W/WW/R/G/B/Y/A (16.4' ea.)		Side-view LED, 4.8W/M, 60LED/M, Non-waterproof, DC12V, White,Warm White, Red, Yellow, Blue, Green, Amber	\$60.00	\$56.00	\$52.00	\$50.00

11	CID5050RGB (16.4' ea.)		Controller built-in Digital LED Strip, 9.6W/M, 8 pixels , 32LED/M, Non-waterproof, DC12V, RGB	\$96.00	\$92.00	\$90.00	\$88.00
12	CIWD5050RGB (16.4' ea.)		Controller built-in Digital LED Strip, 9.6W/M, 8 pixels , 32LED/M, Waterproof, DC12V, RGB	\$100.00	\$96.00	\$94.00	\$92.00
13	CID5050RGB (16.4' ea.)		Controller built-in Digital LED Strip, 32 pixels , 32LED/M, Non-waterproof, DC12V, RGB	\$116.00	\$112.00	\$110.00	\$108.00
14	CIWD5050RGB (16.4' ea.)		Controller built-in Digital LED Strip, 32 pixels , 32LED/M, Waterproof, DC12V, RGB	\$120.00	\$116.00	\$114.00	\$112.00
15	CID5050RGB (16.4' ea.)		Controller built-in Digital LED Strip, 48 pixels , 48LED/M, Non-waterproof, DC12V, RGB	\$136.00	\$132.00	\$130.00	\$128.00
16	CIWD5050RGB (16.4' ea.)		Controller built-in Digital LED Strip, 48 pixels , 48LED/M, Waterproof, DC12V, RGB	\$140.00	\$136.00	\$134.00	\$132.00
17	3014W/WW/R/G /B/Y/A (16.4' ea.)		3014 LED strip,6W/M, 60LED/M, Non-waterproof , DC12V, White,Warm White, Red, Yellow, Blue, Green, Amber	\$36.00	\$34.00	\$32.00	\$30.00
18	W3014W/WW/R /G/B/Y/A (16.4' ea.)		3014 LED strip,6W/M, 60LED/M, Waterproof , DC12V, White,Warm White, Red, Yellow, Blue, Green, Amber	\$40.00	\$38.00	\$36.00	\$34.00
19	3014W/WW/R/G /B/Y/A (16.4' ea.)		3014 LED strip,12W/M, 120LED/M, Non-waterproof , DC12V, White,Warm White, Red, Yellow, Blue, Green, Amber	\$54.00	\$52.00	\$50.00	\$48.00
20	W3014W/WW/R /G/B/Y/A (16.4' ea.)		3014 LED strip,12W/M, 120LED/M, Waterproof , DC12V, White,Warm White, Red, Yellow, Blue, Green, Amber	\$58.00	\$56.00	\$54.00	\$52.00
21	3528PP/PK, 5050PP/PK,335 PP/PK (16.4' ea.)		3528, 5050, 335 Purple, Pink	Add \$15/reel compare other colors			

22	3528PP/PK, 5050PP/PK,335 PP/PK (16.4' ea.)		3528, 5050, 335 Purple, Pink	Add \$15/reel compare other colors			
23	U-TB25		25CM, 9LED, Connectable	\$8.00	\$7.00	\$6.00	\$5.00
24	U-TA120		4Ft long, 90LED, connectable,	\$44.00	\$40.00	\$38.00	\$36.00
25	U-TC60		2Ft long, 30LED, connectable	\$24.00	\$22.00	\$20.00	\$18.00
26	U-TA100		100cm long, 60LED, connectable	\$40.00	\$36.00	\$34.00	\$32.00
27	U-TA50		50CM long, 30LED, connectable	\$24.00	\$22.00	\$20.00	\$18.00
28	U-TD50		50cm long, 30LED, Pirahna type, connectable	\$20.00	\$18.00	\$16.00	\$16.00
29	U-TE50		50CM long, 30LED,connectable	\$20.00	\$18.00	\$16.00	\$16.00
30	DR3528, DR5050		Double Row strip, 3528, 5050 series	Double the price of the standard 3528 or 5050 strip			

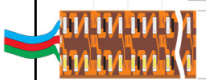
Specs for LED Strips / Ribbons



Product name: 5050 SMD Flex Ribbon Light

Part no.: 5050W/RGB/R/G/B/Y/WW

Dimension: 1000mm*12mm

PCB Thickness : 0.2CM

Working Voltage: 12V DC, 24V DC available

Working Current: 600mA /360mA

Power: 7.2W(30LED at 12V) or 14.4W (60LEDs)

LED View Angle: 120°

LED Qty: 150pcs / 300pcs 5050SMD

LED Spacing: 34mm

Package: 5M / reel

Luminous Flux: 16Lm per LED

Cutable Section Length: every 3 LEDs (5cm for 30LED/m) 6LED 10cm for 60LED/M

Weight: 140g

Qty per Carton: 50 reels

IP: 20 / 68

Wavelength or CCT: Red 623±3nm, Yellow 589±3nm, Blue 465±3nm, Green 523±3nm,

White 2700K-9000K, RGB 624±3nm, 520-525nm,465-470nm

LED Intensity(at dc12v): Red > 1600mcd, Yellow > 1600mcd, Blue > 600mcd, Green > 2800mcd,

White > 4600mcd, RGB(R390,G900,B310)

Working Enviroment: -40°C-80°C

Forward Voltage drop: 3.2V

LED chip manufacturer: Taiwan Epistar

Lumens per watt: 90Lm

Chip type: AlInGan

Max Junction Temperature: 100°C

Optimum working temperature: 20°C-55°C

PCB material: FPC

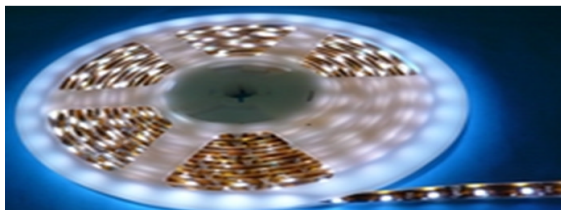

Product name: 3528 SMD Flex Ribbon Light

Part no.: 3528W/R/G/B/Y/WW

Dimension: 1000mm*8mm

PCB Thickness : 0.2CM

Working Voltage: 12V DC or 24VDC

Working Current: 400mA or 200mA

Power: 4.8W

LED View Angle: 120°
LED Qty: 60pcs LEDs/M 3528 SMD
LED Spacing: 17mm
Package: 5M / reel
Luminous Flux: 300-360Lm/M
Cuttable Section Length: every 3 LEDs (5cm)
Weight: 100gram,
Qty per Carton: 80 reels
IP: 20 / 68
Wavelength or CCT: Red 623±3nm, Yellow 589±3nm, Blue 465±3nm, Green 523±3nm,
White 2700K-9000K, RGB 624±3nm, 520-525nm,465-470nm
LED Intensity(at dc12v): Red > 900mcd, Yellow > 900mcd, Blue > 400mcd, Green > 1200mcd,
White > 1600mcd, RGB(R390,G900,B310)
Working Enviroment: -40°C-80°C
Forward Voltage drop: 1.9-2.2V
LED chip manufacturer: Taiwan Epistar
Lumens per watt: 90Lm
Chip type: AlInGan
Max Junction Temperature: 100°C
Optimum working temperature: 20°C-55°C



Product Name: Shelving or Undercabinet Mini Light Bar

Part No.: U-TB25

Light Length: 25cm

Power: 2.16W

LED Type: 5050 3 chips in one SMD

Max Connection Length: 5 meters

LED Q'ty: 9pcs

Protection Grade: IP67

Light Color: RGB, White CCT(3500K-7000K)

Input Voltage: 12V DC

Input Current: 180 m A

Beam Angle: 120 degree

Luminous Flux: 135lm

Luminous Intensity: 5000 mcd/LED

U-TB25 is a small light bar made from a LED Flex Strip and a rectangular pc housing. It is designed to replace the undercabinet bulbs and spot lamps. Its small demension makes it very useful to fix in different places where as long as you can imagine. The ultra-brightness that the 3-chips-in-one 5050 SMDs emit will surely satisfy your diverse demands. You can freely connect many of this light in series up to 5 meters with one configured power supply, so it also can be used as ceiling profile lighting etc.

Application: cabinet and undercabinet lighting, ceiling profile lighting, commodity lighting, outdoor decoration



Product Name: LED Undercabinet Light Bar

Part No.: U-TA120

Light Length: 120cm

LED Type: 5050 SMD

LED Q'ty: 90pcs

Light Color: RGB, White CCT(3500K-7000K)

Input Voltage: 12V DC or 24V DC

Power: 21.6W

Input Current: 1.8 A

Beam Angle: 120 degree

Luminous Flux:1200lm

Luminous Intensity; R700, G1400, B350, W 1400

Dominant Wavelength : R620-630, G520-525, B435-470

Material: aluminum housing, pc cover

U-TA120 is a 4ft light bar designed according to current home and commercial lighting decoration demand. It is full of modern innovation ideas, which complete expresses simplicity and streamline of design style. With low voltage input, it saves more than 90% electricity meanwhile brings you the best color temperature you can imagine. It has all advantages that all leading edge products may have and the most important it can be red, blue, green, full color changing and common white or amber. Also you can control it as you required with an external controller to make it change colors, so that to make it work as a wall washer. Another, the U-TA120 supports free connection of many of this lamp in series, you just need to power them by a adequate power supply.

Application: undercabinet lighting, cabinet decoration, wall washer.



Product Name: Mini Aluminum Housing LED Undercabinet Light Bar

Part No.: U-TC60

Dimension: 60cm*1.2cm*0.7cm

LED Type: 5050 3 -chips-in-one SMD

LED Q'ty: 30pcs

Light Color: RGB, White CCT(3500K-7000K)

Input Voltage: 12V DC

Power: 7.2W

Input Current: 600 mA

Beam Angle: 120 degree

Luminous Flux: 210Lm

Luminous Intensity; R700, G1400, B350, W 1400

Dominant Wavelength : R620-630, G520-525, B435-470

Material: aluminum housing, pc cover

Protection Grade: IP67

U-TC60 is a small light bar made from a LED Flex Strip and a rectangular aluminum housing. It is designed to replace the undercabinet bulbs and spot lamps. Its small dimension makes it very useful to fix in different places where as long as you can imagine. The ultra-brightness that the 3-chips-in-one 5050 SMDs emit will surely satisfy your diverse demands. You can freely connect many of this light in series up to 5 meters with one configured power supply,

so it also can be used as ceiling profile lighting etc. Another, its aluminum housing acts as an useful and better heat sink so that it can be used in hot areas such as desert districts.

Application: cabinet and undercabinet lighting, ceiling profile lighting, commodity lighting, outdoor decorations etc.



Product: 5050 SMD DREAM COLOR LED STRIP Part No. DW/D5050RGB (D-Dream, W-Waterproof)

Input Voltage: 5VDC/12VDC

IC type: 1606, 1pcs/2LEDs; 6803, 1pcs/3LEDs

View Angle:120degrees

Operation Environment: -20°C-55°C

Luminous Flux: 192Lm red, 384Lm green, 240Lm blue

Package: 25 reel/carton

Cutable Method: Every 2LEDs, or Every 3LEDs

Size: 5000mm*12mm*4mm

LED Q'ty: 32LED/M, 30LED/M

LED Type: 5050 SMD

Power: 9.6W/M, 6.4W/M

Chip Brand: Epistar

IP: 54 / 68

Weight: 400g/reel

Illustrations

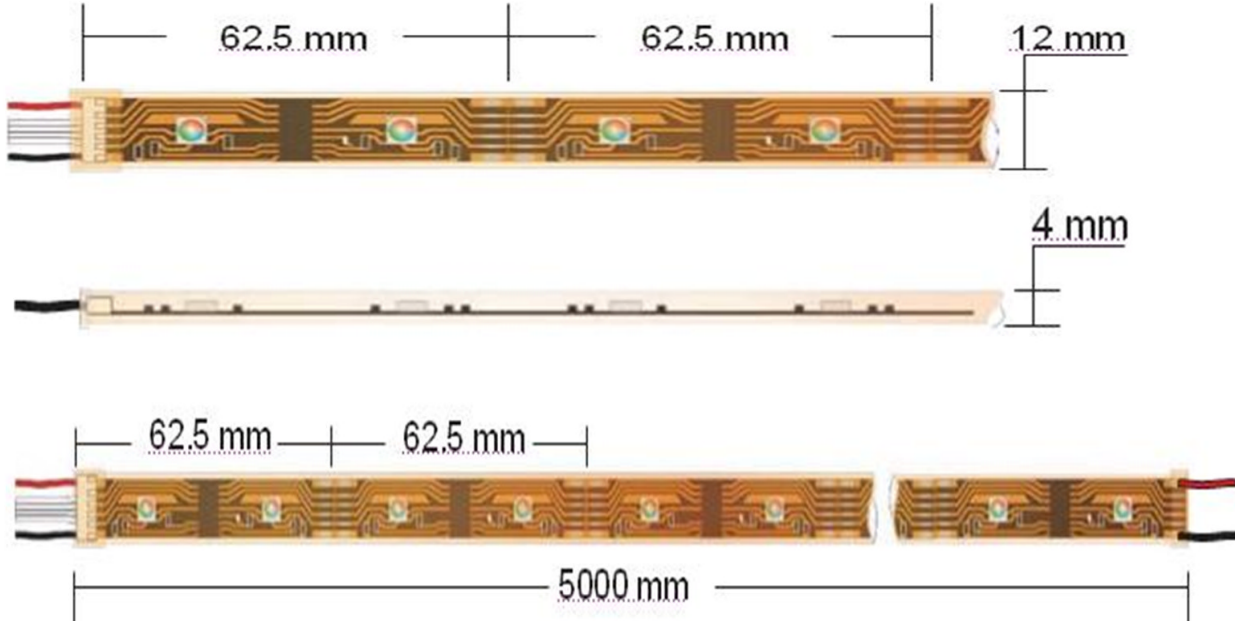

Picture for showing input 5 leads



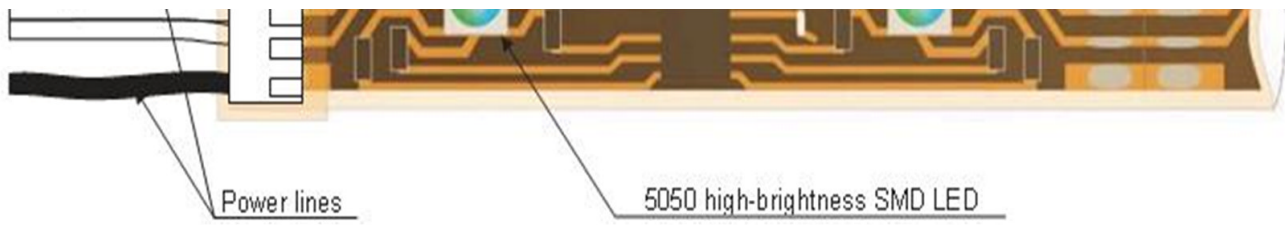

Wiring Diagram

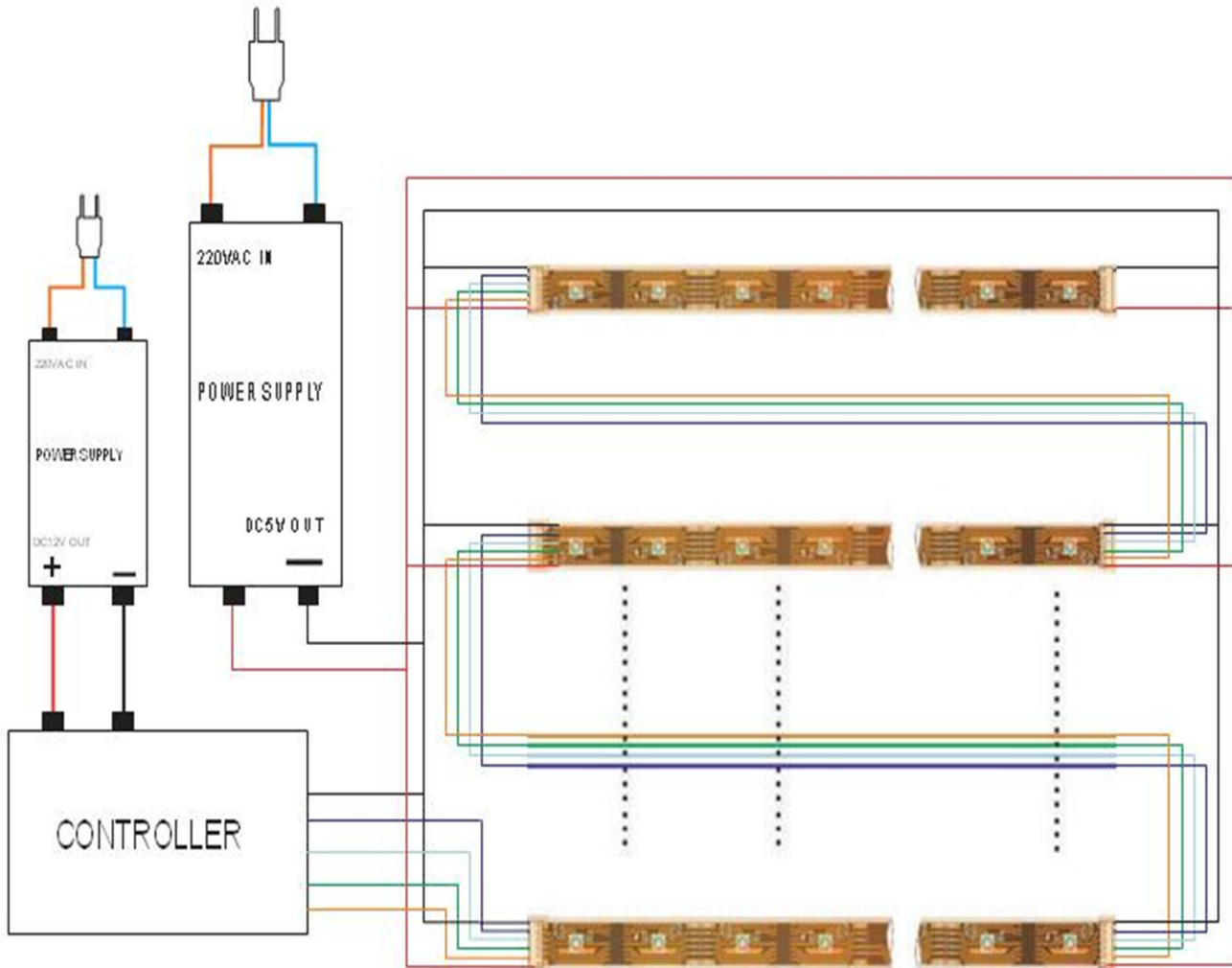

Product Name: LED Undercabinet Light Bar

Part No.: U-TA100

Light Length: 100cm

LED Type: 5050 SMD

LED Q'ty: 60pcs

Light Color: RGB, White CCT(3500K-7000K)

Input Voltage: 12V DC or 24V DC

Power: 14.4W

Input Current: 1.2 A

Beam Angle: 120 degree

Luminous Flux: 800lm

Luminous Intensity; R700, G1400, B350, W 1400

Dominant Wavelength : R620-630, G520-525, B435-470

Material: aluminum housing, pc cover

U-TA120 is a 4ft light bar designed according to current home and commercial lighting decoration demand. It is full of modern innovation ideas, which complete expresses simplicity and streamline of design style. With low voltage input, it saves more than 90% electricity meanwhile brings you the best color temperature you can imagine. It has all advantages that all leading edge products may have and the most important it can be red, blue, green, full color changing and common white or amber. Also you can control it as you required with an external controller to make it change colors, so that to make it work as a wall washer. Another, the U-TA120 supports free connection of many of this lamp in series, you just need to power them by a adequate power supply.

Application: undercabinet lighting, cabinet decoration, wall washer.



Product Name: LED Undercabinet Light Bar

Part No.: U-TA50

Light Length: 50cm

LED Type: 5050 SMD

LED Q'ty: 30pcs

Light Color: RGB, White CCT(3000-7000K)

Input Voltage: 12V DC or 24V DC

Power: 7.2W

Input Current: 600 mA

Beam Angle: 120 degree

Luminous Flux: 335lm

Luminous Intensity; 700-2000mcd

Dominant Wavelength : R620-630, G520-525, B435-470

Material: aluminum housing, pc cover

U-TA50 is a small light bar designed according to current home and commercial lighting decoration demand. It is full of modern innovation ideas, which complete expresses simplicity and streamline of design style. With low voltage input, it saves more than 90% electricity meanwhile brings you the best color temperature you can imagine. It has all advantages that all leading edge products may have and the most important it can be red, blue, green, full color changing and common white or amber. Also you can control it as you required with an external controller to make it change colors, so that to make it work as a wall washer. Another, the U-TA50 supports free connection of many of this lamp in series, you just need to power them by a adequate power supply.

Application: undercabinet lighting, cabinet decoration, wall washer.

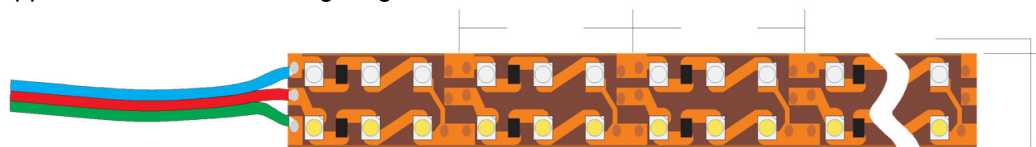

Product Name: DOUBLE ROW / DOUBLE COLOR LED FLEX STRIP

Input Voltage: 12VDC

Size: 4500mm*15mm*2.2mm

View Angle:120degrees

LED Q'ty: 216 LEDs/M

Operation Environment: -20°C-55°C

LED Type: 3528 SMD

Light Color: White+ Blue, or White+ Green, any two colors

Power: 17.28W/M

Luminous Flux: 700 Lumen (white), 280 Lumen (blue)

Chip Brand: Epistar

Package: 20 reel/carton

IP: 20 / 65

Cuttable Method: Every 3LEDs

Weight: 400g/reel

Waterproof type use note: silicon gel coating only no exposure to sunshine

Adhesive 3M back tape.

Light Distribution Diagram

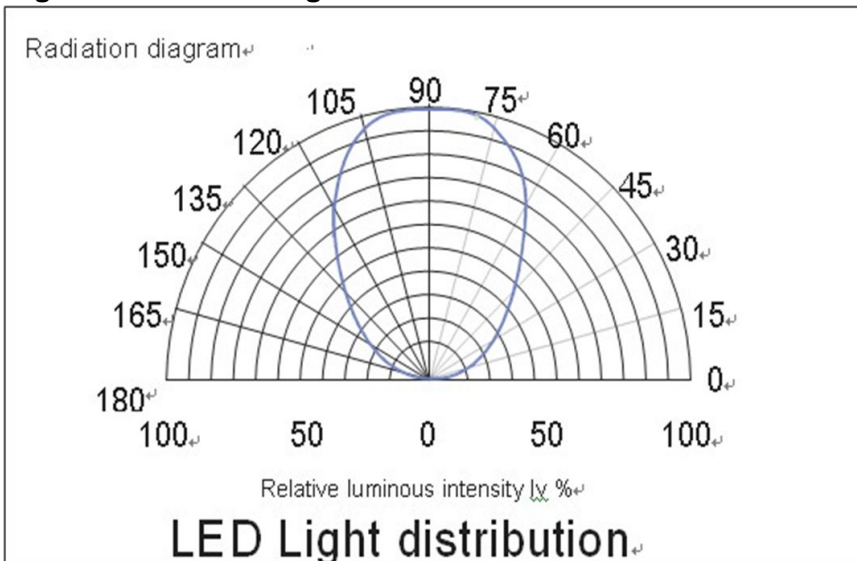

Wiring Diagram

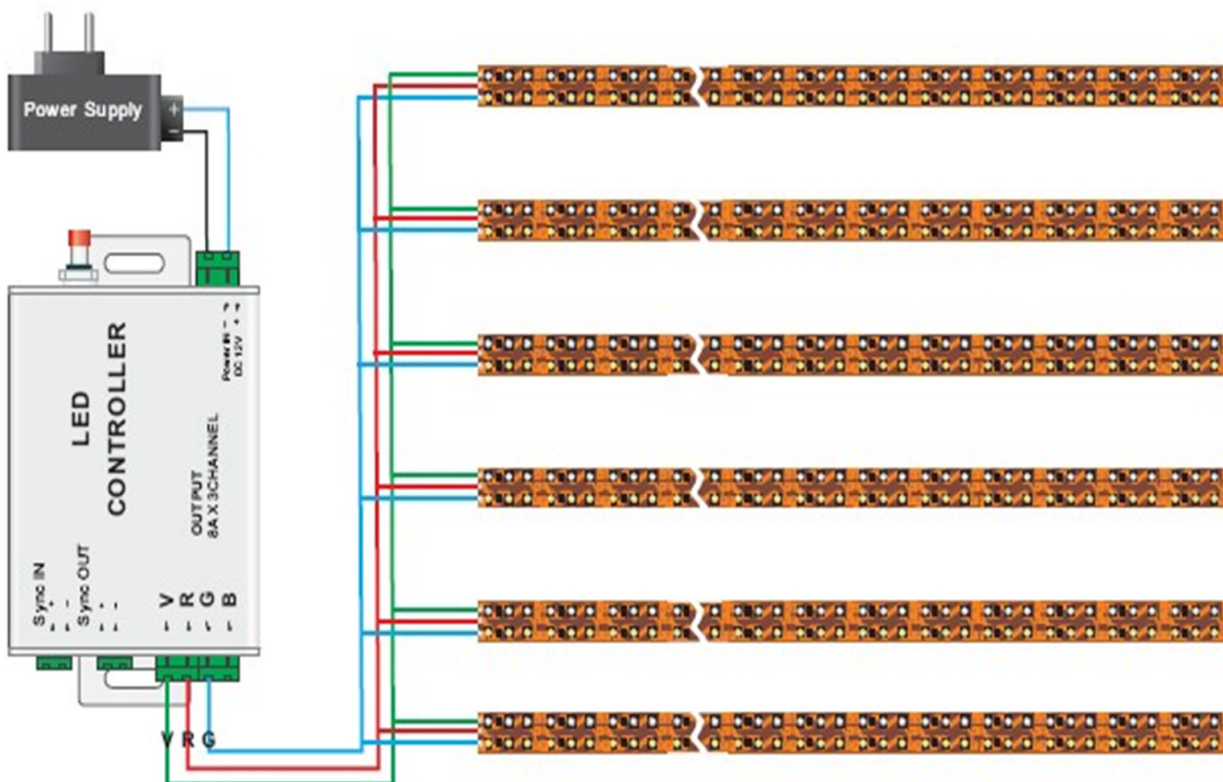

Application: It is made based on the standard 3528 LED Flex Strip Light. With 2 PCBs paralleling together, we get more light output and larger luminous area, so we can use it to such following applications: Cove lighting, commodity lighting, building advertisement, lighting, cabinet or undercabinet lighting, channel letter lighting, residential decoration lighting, even part household lighting etc.

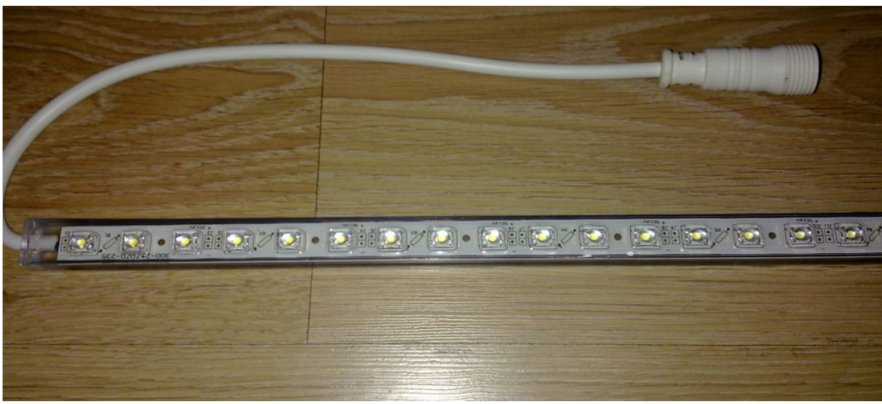

Product Name: Waterproof Piranha LED Light Bar

Part Number: U-TD50

Size: 510mm*18 mm *10mm

LED Qty: 30 PCS LED

Input: DC12V /150mA

Waterproof: IP67

Package: 1PCS / Tube

View Angle: 120 degree

Power: 1.8 Watt

Luminous Flux: 100-130LM

LED Type: Piranha LED F5

Storage Temperature: -40 ~ +80°C

Operating Temperature: -25 ~ +60°C

Circuit & Dimension.(UNIT:±5mm).

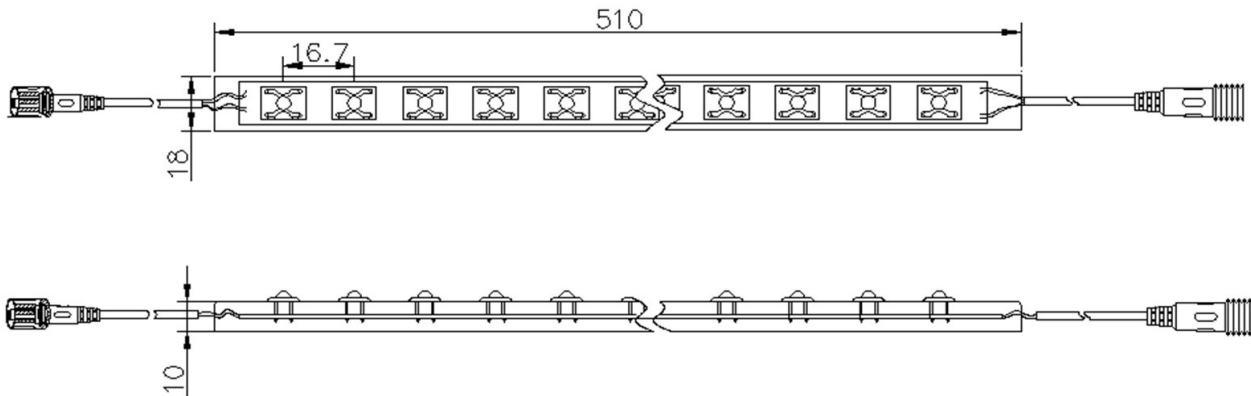

Applications:

- 1). Architectural decorative lighting
- 2). Indoor Decoration
- 3). Auditorium walkway lighting
- 4). Stairway lighting & Decoration
- 5). Border/contour lighting
- 6). Channel letter lighting
- 7). Emergency & Security lighting
- 8). Cove lighting
- 9). Shop-window decoration.

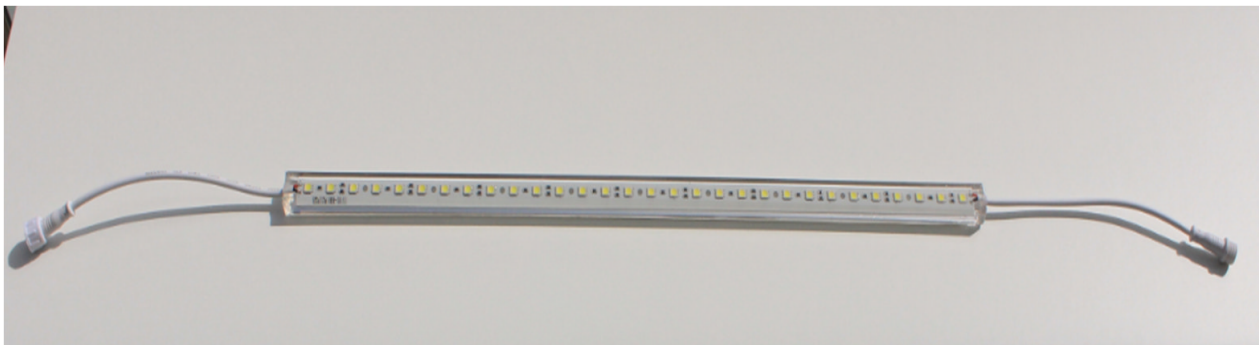

Product Name: Waterproof LED Light Bar**Part Number: U-TE50**

Size: 500mm*9mm*15mm

LED Qty: 30 PCS LED

Input: DC12/24V(Optional)

Waterproof: IP67

Package: 1PCS / Tube

View Angle: 120 degree

Power: 7.2 Watt

Luminous Flux: 480LM

LED Type: 5050 SMD

Storage Temperature: -40 ~ +80°C

Operating Temperature: -40 ~ +60°C

Color Temperature: 3000K/5500K

Color Available: R/G/B/RGB/W/WW

Connection: Waterproof male-female connector wire

Max Connection: 15 meters

Applications:

- 1). Architectural decorative lighting
- 2). Indoor Decoration
- 3). Auditorium walkway lighting
- 4). Stairway lighting & Decoration
- 5). Border/contour lighting
- 6). Channel letter lighting
- 7). Emergency & Security lighting
- 8). Cove lighting
- 9). Shop-window decoration.

**Part Number: CID5050RGB****Coding:** CI--controller integrated

Size: 1000mm*12mm*2mm

D5050RGB-- Digital RGB strip

Input: DC9V/12V(Optional)

LED Qty: 30 PCS LED

Package: 1roll / bag, 50roll/carton

IP: IP68 or IP20

Power: 9.2 Watt

View Angle: 120 degree

LED Type: 5050 SMD

Luminous Flux: 480LM

Operating Temperature: -40 ~ +60°C

Storage Temperature: -40 ~ +80°C

IC Model: 9912

LED Color: RGB

Max Connection: 2048 Pixels or 64 meters

IC Q'ty: 8PCS/M or 8pixels, 32, 48 pixels available

External Controller: Accepted

Control Method: Built-in Digital Controller

Control Mode: 118 or 300 Modes

Remote Controller: 4 Buttons remote available

Actual Connection Length: 15M

Max Remote Control Distance: 200M

Mode Button: A press makes mode +1

Gross Weight: 250g/roll

Auto Button: Mode change, every press makes mode -1.

Speed Button: Speed adjustment, 10 levels

Press Auto and Mode together, mode will change to the 'Auto' mode.

On/Off: Turn on/off

Applications:

- 1). Architectural decorative lighting
- 2). Indoor Decoration
- 3). Auditorium walkway lighting
- 4). Stairway lighting & Decoration
- 5). Border/contour lighting
- 6). Channel letter lighting
- 7). Emergency & Security lighting
- 8). Cove lighting
- 9). Shop-window decoration.

Extra Accessory

Remote Selectable

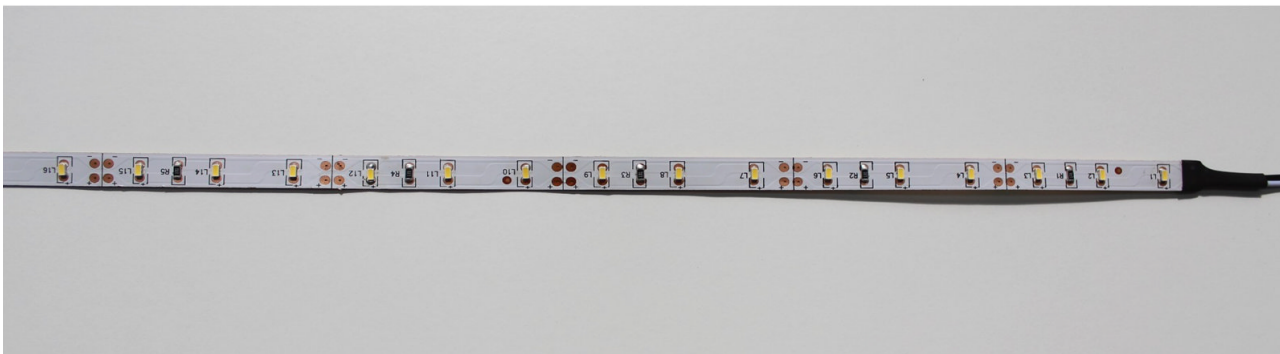

Product Name: 3014 Mid-high Level LED Tape Light

Part Number: 3014 + Color

Size: 1000mm*10mm*2mm

Input: DC12V/24V

Unit Packing: 1roll / bag, 50roll/carton

Power: 6 Watt

LED Type: 3014 SMD

Operating Temperature: -40 ~ +60°C

Forward Voltage: 3.2V

LED Chip: Taiwan Epistar

Cutable Length: 5cm

LED Spacing: 19mm/8.5mm

Chip type: AlInGan

Max Junction Temperature: 100°C

Optimum working temperature: 20 °C-55°C

PCB material: Copper FPC

Coding: 3014---LED model Color----W/WW/Y/B/G

LED Qty: 60 PCS/M, 120LED/M available

IP: IP20 or IP67

View Angle: 120 degree

Luminous Flux: 650Lm/M(60LED)/1300LM/M(120LED)

Storage Temperature: -40 ~ +80°C

LED Color: Single Color

LED Current: 30mA

Weight: 100g/roll

Working Current: 500mA

Unit Pack Length: 5M/Roll